

## ΤΙΜΟΚΑΤΑΛΟΓΟΣ 2022



<b>CAT. A</b>	ANDREA SILVIA; ASSET; DUOMO; GUELL; LOUVRE; NEW BRONX; NEW KENYA;
<b>CAT. B</b>	BELEZA; BRUTUS; CANADA; CASINO'; MUNICH; ROCK; SHORE; PACIFICO, TAY TAY
<b>CAT. C</b>	ALFA; GAMMA; CHARME; GALLA
<b>CAT. D</b>	CAPRI HYDRO, ROMA HYDRO, CROMIA
<b>CAT. 50</b>	ΔΕΡΜΑ MANDRAS
<b>CAT. 60</b>	ΔΕΡΜΑ DOLLARO Ο ΒUFALO
<b>CAT. 80</b>	ΔΕΡΜΑ SAFARI Ο MODENA / SAFARI, MODENA
<b>CAT. 90</b>	ΔΕΡΜΑ LEATHER ART. TONY
<b>CAT. 100</b>	ΔΕΡΜΑ ART. VENERE
<b>P+C</b>	ΔΕΡΜΑ (CAT. 60) + ΥΦΑΣΜΑ
<b>TC*</b>	ΥΦΑΣΜΑ ΠΕΛΑΤΗ



### ΥΛΙΚΑ LUX

ΠΕΡΙΓΡΑΦΗ	ΥΛΙΚΟ	ΤΙΜΗ ΑΝΑ ΘΕΣΗ
3 CM ΑΦΡΟΣ ΜΝΗΜΗΣ	MEMORY	30
ΠΟΥΠΟΥΛΟ+ΑΦΡΟΣ	ΠΟΥΠΟΥΛΟ ΧΗΝΑΣ	40
ΑΦΡΟΣ ΥΨΗΛΗΣ ΠΥΚΝΟΤΗΤΑΣ	HR	30

ΕΙΔΙΚΕΣ ΔΙΑΣΤΑΣΕΙΣ + 20% ΑΝΑ ΤΕΜΑΧΙΟ.

## ΣΥΜΒΟΥΛΕΣ ΓΙΑ ΤΟΥΣ ΠΩΛΗΤΕΣ



ΚΑΘΙΣΜΑ ΧΩΡΙΣ ΡΑΦΕΣ	ΠΡΟΤΕΙΝΟΥΜΕ ΚΑΘΙΣΜΑΤΑ ΧΩΡΙΣ ΓΑΖΙΑ ΜΕ ΤΑ ΠΑΡΑΚΑΤΩ ΥΦΑΣΜΑΤΑ
	ANDREA SILVIA; ASSET; GUELL; GALLA, NEW BRONX; CAPRI HYDRO, CROMIA; ROMA HYDRO
ΚΑΘΙΣΜΑΤΑ ΜΕ ΓΑΖΙΑ	ΠΡΟΤΕΙΝΟΥΜΕ ΚΑΘΙΣΜΑΤΑ ΜΕ ΓΑΖΙΑ ΜΕ ΤΑ ΠΑΡΑΚΑΤΩ ΥΦΑΣΜΑΤΑ
	BELEZA; BRUTUS; CANADA; CASINO'; ROCK; DUOMO; SHORE; PACIFICO LOUVRE; MUNICH; NEW KENYA; TAY TAY ALFA; GAMMA; CHARME;
	ΑΥΤΕΣ ΟΙ ΔΕΡΜΑΤΙΝΕΣ ΔΕΝ ΕΝΔΥΚΝΕΙΟΝΤΑΙ ΓΙΑ ΚΑΘΙΣΜΑ
	ANDREA SILVIA. GUELL.



ΑΝΑΦΕΡΕΤΕ ΕΑΝ ΤΟ ΜΠΡΑΤΣΟ ΕΙΝΑΙ ΕΞΩ Η ΜΕΣΑ ΣΤΟ ΑΝΑΚΛΥΝΔΡΟ





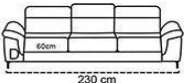
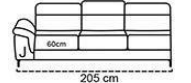
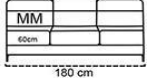

# FELICE

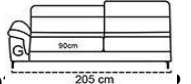

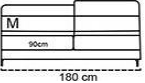
Δ. ΡΑΓΙΑΔΑΚΟΣ ΑΒΕΕ

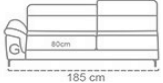
				ΤΙΜΕΣ								EUR		Δ+Υ	ΥΦ ΠΕΛ
	ΘΕΣΕΙΣ	ΠΕΡΙΓΡΑΦΗ	ΜΕΤΑΛ. ΠΟΔΙΑ	CAT. A	CAT. B	CAT. C	CAT. D	CAT. 50	CAT. 60	CAT. 80	CAT. 90	CAT. 100			
	SEATS	DESCRIPTION	METAL LEGS												
	assises	COMPOSITION	PIEDS ACIER												
D3P (3*60)	3	 <b>D3P (3*60)</b>		955	1033	1170	1415	1410	1523	1880	2103	2863	1280	820	
D3P (3*60) 1 BR.	3	 <b>D3P (3*60) 1 BR.</b>		890	958	1075	1285	1285	1380	1688	1878	2530	1165	773	
D3P (3*60) SBR	3	 <b>D3P (3*60) S/BR.</b>		828	883	980	1155	1158	1238	1493	1653	2198	1053	728	
D3P (2*90)	3	 <b>D3P (2*90)</b>		865	940	1073	1313	1305	1413	1763	1980	2720	1180	730	
D3P (2*90) 1 BR.	3	 <b>D3P (2*90) 1 BR.</b>		800	865	978	1183	1178	1273	1570	1755	2388	1068	685	

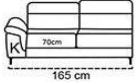
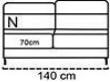



D3P (2*90) SBR	3	 <b>D3P (2*90) S/BR.</b>	735	790	883	1053	1053	1130	1375	1530	2055	953	640
D3P (2*80)	3	 <b>D3P (2*80)</b>	795	865	988	1208	1203	1303	1625	1828	2515	1088	670
D3P (2*80) 1 BR.	3	 <b>D3P (2*80) 1 BR.</b>	730	788	893	1078	1075	1160	1433	1603	2180	973	625
D3P (2*80) SBR	3	 <b>D3P (2*80) S/BR.</b>	665	713	795	948	948	1018	1240	1378	1848	858	580
D2P (2*70)	2	 <b>D2P (2*70)</b>	725	793	908	1118	1110	1205	1510	1700	2350	1008	610
D2P (2*70) 1 BR.	2	 <b>D2P (2*70) 1 BR.</b>	660	715	813	988	983	1063	1318	1475	2015	893	563
D2P (2*70) SBR	2	 <b>D2P (2*70) S/BR.</b>	595	640	718	858	855	920	1123	1250	1683	778	518

# FELICE

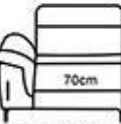

Δ. ΡΑΓΙΑΔΑΚΟΣ ΑΒΕΕ

			ΤΙΜΕΣ										EUR	
ΘΕΣΕΙΣ	ΠΕΡΙΓΡΑΦΗ	ΜΕΤΑΛ. ΠΟΔΙΑ	CAT. A	CAT. B	CAT. C	CAT. D	CAT. 50	CAT. 60	CAT. 80	CAT. 90	CAT. 100	P+T	TC	
SEATS	DESCRIPTION	METAL LEGS												
assises	COMPOSITION	PIEDS ACIER												
D2P (2*60)	2	 D2P (2*60)	658	720	828	1025	1018	1108	1393	1573	2183	925	548	
D2P (2*60) 1 BR.	2	 D2P (2*60) 1 BR.	593	643	733	895	890	965	1200	1348	1850	813	503	
D2P (2*60) SBR	2	 D2P (2*60) S/BR.	528	568	638	765	765	823	1008	1123	1515	698	458	
POL.	1	 ΠΟΛΥΘΡΟΝΑ	428	470	545	680	673	735	930	1053	1470	610	353	

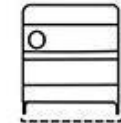
<b>POL. (90) 1 BR</b>	1	 <b>ΠΟΛΥΘΡΟΝΑ</b>	450	490	558	683	271	735	915	1025	1408	613	383
<b>POL (80) 1 BR</b>	1	 <b>ΠΟΛΥΘΡΟΝΑ 1 ΜΠΡ</b>	418	455	518	635	630	683	853	958	1318	570	353
<b>POL (70) 1 BR</b>	1	 <b>ΠΟΛΥΘΡΟΝΑ 1 ΜΠΡ</b>	378	408	465	565	563	610	755	848	1160	513	128
<b>POL (60) 1 BR</b>	1	 <b>ΠΟΛΥΘΡΟΝΑ ΧΩΡΙΣ</b>	343	375	430	530	528	573	287	808	1118	478	288
<b>POL. (90) SBR</b>	1	 <b>ΠΟΛΥΘΡΟΝΑ ΧΩΡΙΣ</b>	385	415	463	553	553	593	720	800	1075	498	338
<b>POL (80) SBR</b>	1	 <b>ΠΟΛΥΘΡΟΝΑ ΧΩΡΙΣ</b>	353	378	423	505	505	540	660	733	983	455	308

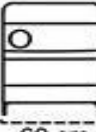
POL (70) SBR	1	 <p>70 cm</p> <p>ΠΟΛΥΘΡΟΝΑ ΧΩΡΙΣ</p>		313	333	370	435	438	468	563	623	828	400	275
POL (60) SBR	1	 <p>60 cm</p> <p>ΠΟΛΥΘΡΟΝΑ ΧΩΡΙΣ</p>		280	300	335	400	400	430	525	583	783	363	243



**FELICE**



Δ. ΡΑΓΙΑΔΑΚΟΣ ΑΒΕΕ

				ΤΙΜΕΣ							EUR		Δ+Υ	ΥΦ ΠΕΛ
	ΘΕΣΕΙΣ SEATS assises	ΠΕΡΙΓΡΑΦΗ DESCRIPTION COMPOSITION	ΜΕΤΑΛ. ΠΟΔΙΑ METAL LEGS PIEDS ACIER	CAT. A	CAT. B	CAT. C	CAT. D	CAT. 50	CAT. 60	CAT. 80	CAT. 90	CAT. 100		
CL (60)		<p>CL/(60)</p>		525	570	645	780	778	840	1038	1163	1585	703	450
CL (70)	2	<p>CL/(70)</p>		588	635	723	880	878	948	1178	1320	1808	788	498
CL (80)		<p>CL/(80)</p>		645	700	798	975	970	1050	1308	1468	2013	885	548
CL (90)		<p>CL/(90)</p>		693	748	845	1018	1015	1095	1348	1508	2045	915	595
ANG. TER.	3	<p>ΓΩΝΙΑΚΟΣ</p>		915	978	1088	1288	1288	1380	1670	1850	2468	1193	803

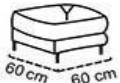
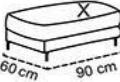
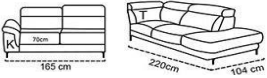
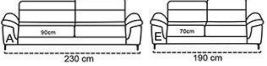
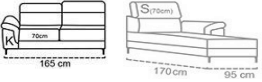
<b>POUF 60*60</b>	0.5	 <b>ΣΚΑΜΠΟ 60Χ60</b>	220	230	250	285	288	305	355	388	495	280	200
<b>POUF 60*90</b>	0.5	 <b>ΣΚΑΜΠΟ 90Χ60</b>	238	253	280	328	330	353	423	468	618	315	210
<b>D2P 92*70) 1BR + ANG. TER.</b>		 <b>2Θ(70)+ΓΩΝΙΑΚΟΣ(70)</b>	1575	1693	1900	2273	2273	2443	2985	3328	4483	2085	1365
<b>D3P (2*90) + D2P (2*70)</b>	5	 <b>D3Θ (90) + D2Θ (70)</b>	1580	1715	1950	2380	2370	2565	3188	3578	4905	2153	1340
<b>D2P (70) 1 BR + CL (70)</b>	4	 <b>D2Θ (70) + ΑΝΑΚΛ (70)</b>	1235	1335	1508	1818	1813	1955	2410	2693	3658	1648	1063

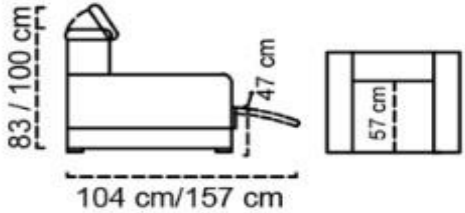





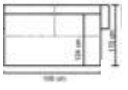
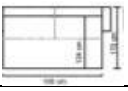

<b>ΑΞΕΣΟΥΑΡ</b>	<b>EUR</b>	
ΜΗΧ/ΣΜΟΣ ΡΙΛΑΞ ΗΛΕΚ/ΚΟΣ	<b>235</b>	
ΜΠΑΤΑΡΙΑ ΛΙΘΙΟΥ	<b>86</b>	
ΘΗΡΑ USB	<b>33</b>	

FELYNE, FIOREELLO, AZZURRA

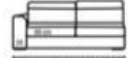

Δ. ΡΑΓΙΑΔΑΚΟΣ ΑΒΕΕ

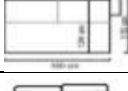
			ΤΙΜΕΣ										EUR		Δ+Υ	ΥΦ ΠΕΛ
ΘΕΣΕΙΣ	ΠΕΡΙΓΡΑΦΗ	ΜΕΤΑΛ. ΠΟΔΙΑ	CAT. A	CAT. B	CAT. C	CAT. D	CAT. 50	CAT. 60	CAT. 80	CAT. 90	CAT. 100					
SEATS	DESCRIPTION	METAL LEGS														
assises	COMPOSITION	PIEDS ACIER														
<b>D3P - D3 PL. - 3 Μ.</b>	3	D3ΘP MAX (3csX 70 cm)		12	765	855	1015	1305	1285	1415	1838	2100	2995	1205	603	
	3	D3Θ MAX (3cs x 70 cm) 1 BR.		6	703	785	928	1185	1168	1285	1660	1895	2693	1073	560	
	3	D3Θ MAX (3cs x 70 cm) SBR		0	643	713	838	1065	1050	1153	1483	1690	2390	943	515	
	3	D. 3/3 (3csx60) - ΚΡΕΒΑΤΙ		12	1025	1128	1308	1635	1618	1768	2243	2540	3550	1503	843	
	3	D 3/3 (3csx60) 1 BR ΚΡΕΒΑΤΙ		6	963	1055	1218	1515	1503	1635	2065	2335	3248	1370	798	
	3	D 3/3 (3csx60) SBR ΚΡΕΒΑΤΙ		0	903	985	1130	1395	1385	1505	1888	2128	2945	1240	755	
	3	D. 3/3 (3csx60)		12	765	855	1015	1305	1285	1415	1838	2100	2995	1205	603	
	3	D 3/3 (3csx60) 1 BR		6	703	785	928	1185	1168	1285	1660	1895	2693	1073	560	
	3	D 3/3 (3csx60) SBR		0	643	713	838	1065	1050	1153	1483	1690	2390	943	515	
	3	D3P MAX LETTO (2cs x 90 cm)		12	953	1055	1238	1563	1545	1693	2170	2465	3478	1428	770	

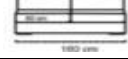











3	D3P MAX (2cs 90 cm) 1 BR KPEBATI		6	893	985	1148	1443	1428	1563	1993	2260	3175	1298	728
3	D3P MAX (2cs 90 cm) SBR KPEBATI		0	830	915	1060	1323	1310	1430	1815	2055	2870	1165	683
3	D3P MAX (2csX 90 cm)		12	693	785	945	1233	1210	1343	1763	2028	2923	1130	533
3	D3P MAX (2cs x 90 cm) 1 BR.		6	633	713	855	1113	1095	1213	1588	1823	2620	1000	488
3	D3P MAX (2cs x 90 cm) SBR		0	570	643	768	993	978	1080	1410	1615	2315	868	445
3	D3P MAX KPEBATI (2cs x 80 cm)		12	953	1055	1238	1563	1545	1693	2170	2465	3478	1428	770
3	D3P MAX (2cs 80 cm) 1 BR KPEBATI		6	893	985	1148	1443	1428	1563	1993	2260	3175	1298	728
3	D3P MAX (2cs 80 cm) SBR KPEBATI		0	830	915	1060	1323	1310	1430	1815	2055	2870	1165	683
3	D3P MAX (2csX 80 cm)		12	693	785	945	1233	1210	1343	1763	2028	2923	1130	533
3	D3P MAX (2cs x 80 cm) 1 BR.		6	633	713	855	1113	1095	1213	1588	1823	2620	1000	488
3	D3P MAX (2cs x 80 cm) SBR		0	570	643	768	993	978	1080	1410	1615	2315	868	445

**FELYNE, FIOREELLO,  
AZZURRA**



Δ. ΡΑΓΙΑΔΑΚΟΣ ΑΒΕΕ

			ΤΙΜΕΣ										EUR		Δ+Υ	ΥΦ ΠΕΛ
ΘΕΣΕΙΣ	ΠΕΡΙΓΡΑΦΗ	ΜΕΤΑΛ. ΠΟΔΙΑ	CAT. A	CAT. B	CAT. C	CAT. D	CAT. 50	CAT. 60	CAT. 80	CAT. 90	CAT. 100					
SEATS	DESCRIPTION	METAL LEGS														
assises	COMPOSITION	PIEDS ACIER														
<b>D2P - D2 PL. - 2 M.</b>	2	D2P MAX ΚΡΕΒΑΤΙ (2 cs.x 70 cm)		12	768	843	975	1213	1203	1310	1655	1870	2605	1130	635	
	2	D2P MAX 1BR ΚΡΕΒΑΤΙ (2 cs.x 70 cm)		6	708	773	885	1093	1085	1178	1478	1665	2303	1000	593	
	2	D2P MAX ΚΡΕΒΑΤΙ SBR (2 cs.X 70 cm)		0	645	700	798	973	968	1048	1300	1460	2000	868	548	
	2	D2P MAX (2 cs.x 70 cm)		12	568	633	748	955	940	1035	1338	1525	2165	900	450	
	2	D2P MAX 1BR (2 cs.x 70 cm)		6	505	560	658	835	823	903	1160	1320	1863	768	408	
	2	D2P MAX SBR (2 cs.X 70 cm)		0	445	490	570	715	708	773	983	1113	1560	638	363	
	2	D2P LETTO (2 cs.x 60 cm)		12	768	843	975	1213	1203	1310	1655	1870	2605	1130	635	
	2	D2P 1BR ΚΡΕΒΑΤΙ (2 cs.x 60 cm)		6	708	773	885	1093	1085	1178	1478	1665	2303	1000	593	
	2	D2P ΚΡΕΒΑΤΙ SBR (2 cs.X 60 cm)		0	645	700	798	973	968	1048	1300	1460	2000	868	548	

1P / 1PL. / 1 M.	2	D2P (2 cs.x 60 cm)		12	568	633	748	955	940	1035	1338	1525	2165	900	450
	2	D2P 1BR (2 cs.x 60 cm)		6	505	560	658	835	823	903	1160	1320	1863	768	408
	2	D2P SBR (2 cs.X 60 cm)		0	445	490	570	715	708	773	983	1113	1560	638	363
	1	ΠΟΛΥΘΡΟΝΑ (60 CM)		12	408	453	530	670	663	725	930	1058	1490	655	330
	1	ΠΟΛΥΘΡΟΝΑ 1 BR. (90 cm)		6	410	453	530	668	660	723	923	1050	1475	623	333
	1	ΠΟΛΥΘΡΟΝΑ 1 BR. (80 cm)		6	410	453	530	668	660	723	923	1050	1475	623	333
	1	ΠΟΛΥΘΡΟΝΑ 1 BR. (70 cm)		6	348	380	440	550	545	595	753	853	1188	525	285
	1	ΠΟΛΥΘΡΟΝΑ 1 BR. (60 cm)		6	348	380	440	550	545	595	753	853	1188	525	285
	1	ΠΟΛΥΘΡΟΝΑ SBR (90 cm)		0	350	383	443	548	543	593	748	843	1173	490	290
	1	ΠΟΛΥΘΡΟΝΑ SBR (80 cm)		0	350	383	443	548	543	593	748	843	1173	490	290
1	ΠΟΛΥΘΡΟΝΑ SBR (70 cm)		0	285	310	353	430	428	463	575	645	885	393	243	
1	ΠΟΛΥΘΡΟΝΑ SBR (60 cm)		0	285	310	353	430	428	463	575	645	885	393	243	

**FELYNE, FIOREELLO,  
AZZURRA**













Δ. ΡΑΓΙΑΔΑΚΟΣ ΑΒΕΕ

				ΤΙΜΕΣ										EUR		Δ+Υ	ΥΦ ΠΕΛ
ΘΕΣΕΙΣ	ΠΕΡΙΓΡΑΦΗ	ΜΕΤΑΛ. ΠΟΔΙΑ	CAT. A	CAT. B	CAT. C	CAT. D	CAT. 50	CAT. 60	CAT. 80	CAT. 90	CAT. 100						
SEATS	DESCRIPTION	METAL LEGS															
assises	COMPOSITION	PIEDS ACIER															
ANG.	1.5	ΓΩΝΙΑΚΟ (100X100)		0	393	433	500	625	620	678	858	973	1358	578	323		
		ΓΩΝΙΑΚΟ (104X104)		0	393	433	500	625	620	678	858	973	1358	578	323		
		ΓΩΝΙΑΚΟ ΜΕΓΑΛΟ (144*144)		6	765	855	1015	1305	1285	1415	1838	2100	2995	1205	603		
MERIDIANA/MERIDIENN	2	ΑΝΑΚΛΥΝΔΡΟ 90cmX110cm		6	468	505	570	688	685	740	913	1020	1385	630	400		
	2	ΑΝΑΚΛΥΝΔΡΟ 80cmX110cm		6	468	505	570	688	685	740	913	1020	1385	630	400		
	2	ΑΝΑΚΛΥΝΔΡΟ 70cmX110cm		6	383	410	463	553	553	595	730	813	1098	515	330		
	2	ΑΝΑΚΛΥΝΔΡΟ 60cmX110cm		6	383	410	463	553	553	595	730	813	1098	515	330		
	2	ΑΝΑΚΛΥΝΔΡΟ XXL 90cm		9	478	530	618	780	773	845	1083	1230	1733	728	388		



ΡΟΥΦ / CHEST / ГАБУРЕТКА /

2	ΑΝΑΚΛΥΝΔΡΟ ΑΠΘΘ. XXL 90cm		9	645	698	788	950	948	1020	1258	1405	1908	903	555
2	ΑΝΑΚΛΥΝΔΡΟ XL 80cm 105 cm		9	478	530	618	780	773	845	1083	1230	1733	728	388
2	ΑΝΑΚΛΥΝΔΡΟ ΑΠΘΘ. XL 80cm		9	645	698	788	950	948	1020	1258	1405	1908	903	555
2	ΑΝΑΚΛΥΝΔΡΟ MAX (70 cm <sup>95</sup> ) cm		9	413	458	535	678	670	735	943	1070	1510	638	333
2	ΑΝΑΚΛΥΝΔΡΟ MAX (70cm)		9	560	605	685	825	825	888	1095	1225	1665	793	483
2	ΑΝΑΚΛΥΝΔΡΟ 60cm		9	413	458	535	678	670	735	943	1070	1510	638	333
2	ΑΝΑΚΛΥΝΔΡΟ ΜΕ ΑΠΘΘ. (60cm)		9	560	605	685	825	825	888	1095	1225	1665	793	483
	ΣΚΑΜΠΟ ΜΕ ΑΠΘΘ. (60*60 cm)		12	193	205	225	265	368	385	443	480	600	353	270
	ΣΚΑΜΠΟ ΜΕ ΑΠΘΘ. (104*50 cm)		12	238	258	295	363	360	390	488	548	758	330	200
	ΣΚΑΜΠΟ ΜΕ ΑΠΘΘ. (104*60 cm)		12	248	270	310	385	380	415	523	590	818	348	205

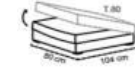
1	ΣΚΑΜΠΟ ΜΕ ΑΠΟΘ. (104*70cm)		12	255	280	323	403	395	433	545	615	858	360	213
	ΣΚΑΜΠΟ ΜΕ ΑΠΟΘ. (104*80cm)		12	270	298	343	425	420	458	578	655	910	383	225
	ΣΚΑΜΠΟ ΜΕ ΑΠΟΘ. (104*90cm)		12	285	313	363	450	443	483	613	693	965	403	235
	ΣΚΑΜΠΟ ΜΕ ΑΠΟΘ. (90*66cm)		12	310	325	358	410	413	435	515	565	735	393	278

## ΣΥΝΘΕΣΕΙΣ

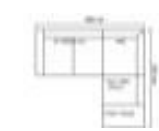
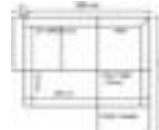

Δ. ΡΑΓΙΑΔΑΚΟΣ ΑΒΕΕ

			ΤΙΜΕΣ										EUR	
ΘΕΣΕΙΣ	ΠΕΡΙΓΡΑΦΗ	ΜΕΤΑΛ. ΠΟΔΙΑ	CAT. A	CAT. B	CAT. C	CAT. D	CAT. 50	CAT. 60	CAT. 80	CAT. 90	CAT. 100	Δ+Υ	ΥΦ ΠΕΛ	
SEATS	DESCRIPTION	METAL LEGS												
assises	composition	Pieds acier												
4.00	2Θ max ΚΡΕΒ + ΑΝΑΚΛ. (70 cm)		35	1120	1230	1423	1770	1755	1913	2420	2738	3813	1638	925
5.00	2Θ max +ΓΩΝΙΑ +ΠΟΛΥΘ +ΣΚΑΜΠΩ (70 cm)		43	1413	1553	1800	2245	2223	2425	3075	3480	4855	2063	1165
5.50	2Θmax ΚΡΕΒ + ΓΩΝΙΑ +ΠΟΛΥΘ +ΣΚΑΜΠΩ (70 cm)		43	1615	1765	2028	2503	2485	2700	3393	3825	5295	2293	1350

<b>ΕΠΙΛΟΓΕΣ</b>	<b>EUR</b>			
ΚΡΕΒΑΤΙ ΣΤΗΝ ΠΟΛΥΘΡΟΝΑ	<b>150</b>	ΜΗΧΑΝΙΣΜΟΣ ΑΝΑΔΙΠΛΩΜΕΝΟΣ "ΙΜΙΑ" ΔΙΠΛΟ ΚΡΕΒΑΤΙ 600€ ΗΜΙΔΙΠΛΟ 330€		
ΜΗΧΑΝΙΣΜΟΣ ΡΙΛΑΞ ΗΛΕΚΤΡΙΚΟΣ	<b>250</b>	ΜΠΑΤΑΡΙΑ ΛΙΘΙΟΥ	<b>130</b>	<b>86</b>
		BRACCIOLI		
ΑΠΟΘ.ΧΩΡΟΣ ΣΤΗΝ ΠΟΛΥΘΡΟΝΑ	<b>70</b>	BR. FIORELLO	<b>0</b>	
		BR. SHARON		<b>50</b>